

OzoneMAX is the Perfect Complement to MineralPURE

When combining the **OzoneMAX (OZ-50)** system with the **MineralPURE (R-40 or RC-50)** ionization system, you will have the most advanced alternative sanitizing system available. The ionization system will help control algae, bacteria, and viruses, while the ozone provides the oxidation needed. This will allow for the maximum reduction of chlorine levels along with the **MineralPURE** ionizer.

RC-50 & OZ-50 COMBO Clearwater Pool System Complete



50,000 gallon pools

RESIDENTIAL POOL MODELS

RESIDENTIAL POOL & SPA MODELS

R-40 – Economical Pool Ionization System



- Economically-priced ionization system
- Handles up to 40,000 gallon pools
- 6 – settings
- Includes test kit & electrode
- NSF listed
- 5 - year warranty

R-40

40,000 gallon pools

SPA-1R – Spa Ionization System



- Premium spa ionization system
- Handles up to 1,000 gallon spas
- Alternating electrode indicators
- Includes test kit & electrode
- 5 - year warranty

SPA-1R

1,000 gallon spas

OZ-SPA – Spa Ionization System



- Vacuum Ultraviolet Ozone System
- Handles up to 1,000 gallon spas
- Heavy duty metal enclosure
- Includes Venturi assembly
- Amazing water clarity
- 1 - year warranty

OZ-SPA

1,000 gallon spas

RC-50 – Platinum Deluxe Ionization System



- Our most sophisticated ionizer ever
- Handles up to 50,000 gallon pools
- Full LCD digital readout display
- Includes test kit & electrode
- Built-in ScaleBlaster® for lime scale control
- 5 - year warranty, NSF & UL listed

RC-50

50,000 gallon pools

OZ-50 – Pool Ozone System



- Vacuum Ultraviolet Ozone System
- Handles up to 50,000 gallon pools
- Heavy duty metal enclosure
- Includes Venturi Manifold Assembly
- Amazing water clarity
- Competitively priced
- 1 - year warranty

OZ-50

50,000 gallons pools

CLEARWATER™
POOL SYSTEMS

The Healthy Alternative to Chlorine



Manufactured by

CLEAR
WATER
ENVIRO TECHNOLOGIES

Established 1989

800-756-SWIM (7946)

ClearwaterPoolSystems.com



Authorized Dealer

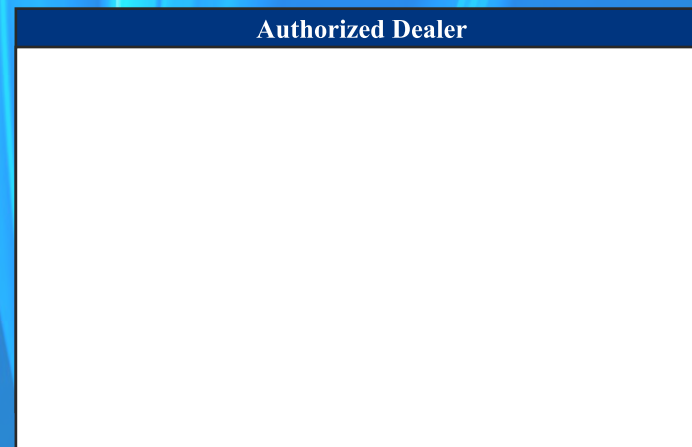

© 2021 Clearwater Enviro Technologies, Inc.
MineralPURE® is a registered trademark of CET

CLM-625
07/21

CLEARWATER™
POOL SYSTEMS
The Healthy Alternative to Chlorine

*Splash Into Our
Oasis of Fun!*



Residential



First, Stow the Goggles...



For nearly 100 years, chlorine has been perceived as the only way to disinfect water in swimming pools and spas. Yet, this method commonly yields red irritated eyes, dry and brittle hair, itchy skin and bleached out swimsuits.

Chlorine is a strong bleach and is dangerous.

The bottom line is, nobody likes CHLORINE!

Let Nature Do Its Thing



The Clearwater Pool System is nature's way of treating water.

By using two of nature's most precious minerals and ozone as a basis for its technology, our system is the most advanced alternative sanitizing system available.

From Movie Stars to Waterparks

From movie-star dolphins to world-famous waterparks, our unique system has allowed operators to safely reduce their chlorine use dramatically for the past 30 years now.



Wet 'n' Wild Las Vegas



Winter the Dolphin*

Now, you can truly enjoy swimming without that chlorine residue on you.

The savings in maintenance and chemical expenses alone will pay for the system itself in no time at all! Enjoy amazing water clarity.

MineralPURE®

MINERALPURE - IONIZATION

It is a well-documented fact that copper & silver ions will help control algae, bacteria and viruses.



The ancient *Greeks* were the first to discover the sanitizing powers of copper.



The *Egyptians* kept their water in silver containers to prevent contamination.

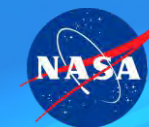

Licensed Technology

In 1967, NASA capitalized on this knowledge and developed an ionization system to go aboard the Apollo flights. They did not want to bring chlorine up into space.

In 1989, NASA granted Clearwater a license to commercialize from technology.

How MineralPURE Works



The MineralPURE system releases precise amounts of copper or copper/silver ions into the water to help control algae, bacteria & viruses.

The MineralPURE system consists of a computerized control box and a scientifically-designed set of electrodes composed of **copper** or **copper/silver**.

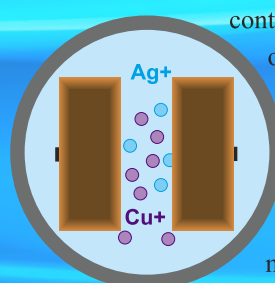

A low-voltage DC charge is sent to the electrodes, releasing ions into the water. They flocculate, or form masses with algae & bacteria and are removed by the existing filtering equipment.

OzoneMAX™

OZONEMAX - VUV OZONE

Ozone is one of the most powerful oxidizers on earth. It is 55 times more powerful than chlorine and reacts 3,000 times faster. It greatly improves water clarity and is effective in controlling cryptosporidium and E. coli while eliminating harmful chloramines.

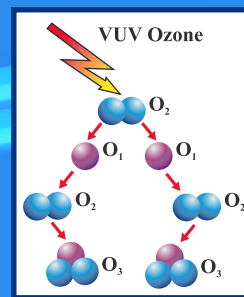

Ozone is produced by splitting oxygen molecules with an ultraviolet lamp. This produces a pair of unstable atoms (O₁) that will combine with normal oxygen molecules (O₂) and forms ozone (O₃) which is injected into the water by a venturi manifold or assembly - included with the system.

How OzoneMAX Works

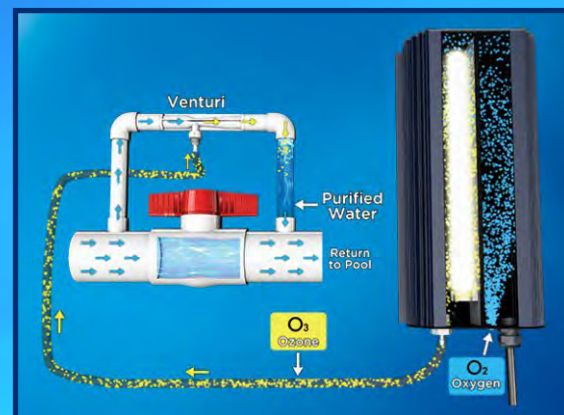

The OzoneMAX produces a powerful oxidizer, Vacuum Ultraviolet (VUV) Ozone, that is injected into the water by a venturi manifold – included with the system.

The ozone will oxidize substances in the water and will dissipate by the time it returns back to the pool and reverts back to oxygen.

Oxidizable Substance(s)
algae, bacteria, viruses, fungi [mold & yeast], suntan oils, body oils, mildew, cysts, chloramines, forms of iron, sweat and urine

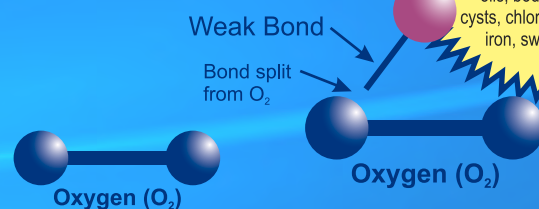

PERFORMANCE COMPARISON



	Clearwater Pool Systems	Salt Generator	CHLORINE
HELPS CONTROL ALGAE?	YES	YES	YES
HELPS CONTROL BACTERIA?	YES	YES	YES
HELPS CONTROL VIRUSES?	YES	NO	NO
CORROSIVE TO EQUIPMENT?	NO	YES	YES
EVAPORATES?	NO	YES	YES
LINKED TO CANCER?	NO	YES	YES
ABSORBS THROUGH SKIN?	NO	YES	YES
FORMS CARCINOGENIC THM's?	NO	YES	YES
REQUIRES USE OF CYANURIC ACID?	NO	YES	YES
HARMFUL TO THE ENVIRONMENT?	NO	YES	YES
COSTS \$100'S A YEAR TO OPERATE?	NO	YES	YES
HARMFUL TO EYES?	NO	NO	YES
IRRITATING TO SKIN?	NO	NO	YES
BLEACHES HAIR?	NO	NO	YES
EXPLOSIVE, UNSAFE TO HANDLE?	NO	NO	YES
DANGEROUS TO STORE?	NO	NO	YES
FADES SWIM SUITS?	NO	NO	YES
UNPLEASANT TO SMELL?	NO	NO	YES
CREATES CHLORAMINES?	NO	NO	YES

CLEARWATER™

POOL SYSTEMS

The Healthy Alternative to Chlorine

The most advanced alternative sanitizing system available!

How The Combo System Is Installed

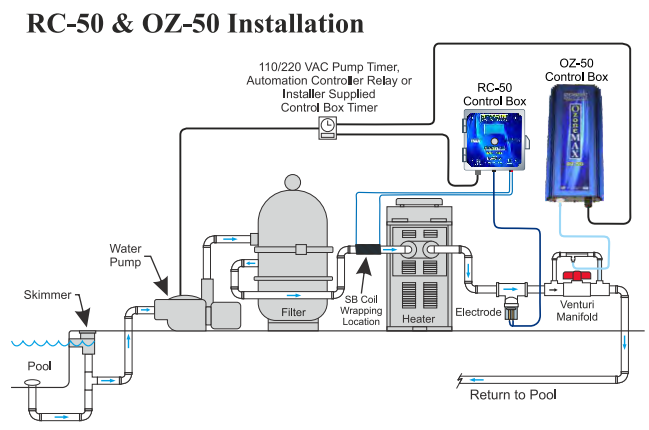

*Dolphin Tale © Alcon Film LLC/Warner Brothers